

PGM ORE PROCESSING AT IMPALA'S UG-2 CONCENTRATOR IN RUSTENBURG, SOUTH AFRICA.

EUGENE NEL AND JOHAN THERON - IMPALA PLATINUM LTD.; CHRIS MARTIN AND HANS RAABE - SGS

ABSTRACT

Impala Platinum Limited is the world's second largest platinum producer, producing more than 1.7 million ounces of the precious metal last year, much of this from the UG-2 reef located in the Bushveld Complex, South Africa. As part of Impala's ongoing expansion programme, tonnage through their principal UG-2 processing facility, near Rustenburg, was increased 40% in 2001.

To accommodate the increased throughput, the role of the existing primary mills was converted from conventional semi-autogenous grinding units, to attrition and selective grinding units, operating in fully autogenous mode. The finer chromite and coarser silicate components in the mill discharge are then separated by screening and processed in dedicated circuits downstream. This way, the need to spend considerable capital to increase primary grinding capacity was averted.

In the last year, considerable work has been conducted to evaluate and optimise the two downstream circuits. This has involved an optimisation programme of sampling and diagnostic flotation testing, supported with QemSCAN analysis. This paper will describe the operation of the new circuit. It will also describe some of the more novel aspects and interesting findings from the optimisation programme.

INTRODUCTION

The South African platinum industry is the world's largest producer of platinum and the world's second largest producer of palladium. Located in a wide area north of Johannesburg, the industry mines ores from the Bushveld Complex, one of the world's great mineral treasure chests, containing over 70 percent of the world's platinum, as well as extensive reserves of the other PGE (platinum group elements), chrome, manganese and vanadium. The industry employs about 180,000 people in, predominantly, underground mines, which together form an almost unbroken circle of mining operations 200 km in diameter.

The development of fuel cell technology, and the growth of the jewellery market in the Far East has fuelled a strong rise on the global demand for platinum. This, coupled with the favourable rand/dollar exchange rate, has driven considerable expansion in the industry in recent years. All the major operators have expanded production. While the platinum industry has traditionally been exclusively operated by a small number of South

African-based companies, several new companies have opened platinum mines in recent years, including South African-based "Black-Empowerment" companies, as well as junior mining companies based in Australia, Canada and the United Kingdom.

Impala Platinum Limited is the second largest platinum producer globally, producing 1.7 million ounces of platinum in 2002/2003, primary from operations on the Bushveld Complex (Figure 1). Consistent with the remainder of the industry, Impala has committed to a significant expansion in production, with some of this expansion coming from the increased processing of ore through the UG-2 plant, located 20 km NW of Rustenburg.

This plant expansion and optimisation project is the subject of this paper. The philosophy behind the flowsheet selected for the expansion, some of which represents an interesting departure from traditional mineral processing thinking, will be described. The approach and challenges faced during commissioning will be described. Finally, the programmes initiated for plant optimisation and to exploit opportunities for improvements in metallurgical performance will also be described.

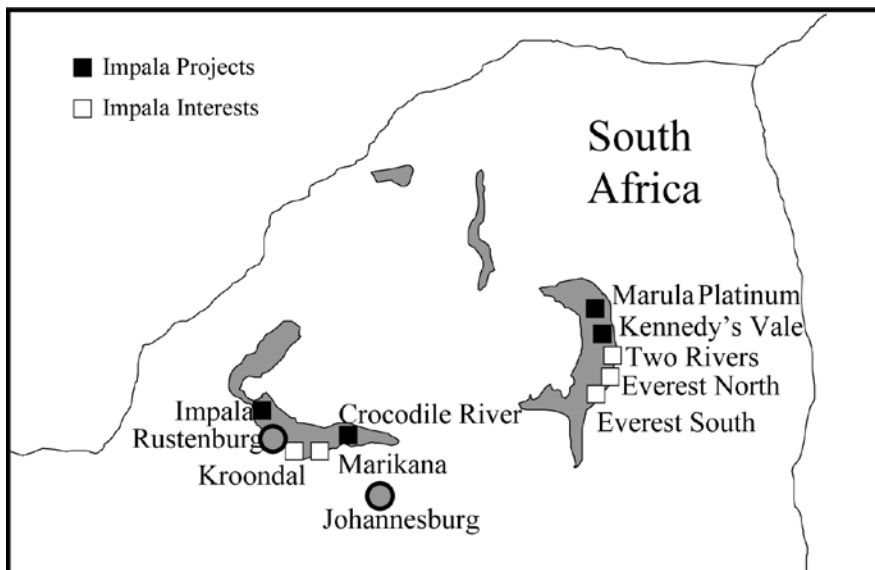

Figure 1: Geographic Location of the Impala Projects and Interests in South Africa

However, largely, the PGM are finely disseminated, the average grain size being about 10 microns, so that grain size, liberation and association tend to dictate mineral floatability. Platinum group mineral grain size and association can be split into four categories:

- Coarse PGM (roughly 5% of all PGE)
- PGM associated with base metal and iron sulphides (40%)
- PGM occurring on host mineral grain boundaries (30%)
- PGM locked in silicates (25%)

Those PGM attached to sulphide minerals can be recovered by maximising the flotation of the base metal and iron sulphides. Those occurring on grain boundaries are preferentially released during grinding, so are quite adequately liberated through a relatively coarse primary grind, particularly if the grind is operated in a more attritioning style. The remaining

UG-2 ORE

UG-2 ore is the second most mined source of PGE in the Bushveld Complex. Located in a reef close to and largely parallel to the historically-mined Merensky Reef, UG-2 has always been an enticing source of PGE, but metallurgical difficulties delayed its extraction and processing until relatively recently.

comprise roughly 70% of the PGM (platinum group minerals) in the UG-2 plant feed, the remainder largely being alloys of iron, lead, arsenic and antimony, or tellurides. As is typical of such ores, UG-2 platinum group mineralisation is highly complex.

UG-2 MINERALOGY

HOST MINERALOGY

UG-2 ore contains two dominant suites of mineralisation: chromite and aluminium silicate-based mineralisation. The feed to Impala's UG-2 plant contains 22 - 24% Cr₂O₃, or roughly 50% chromite. The aluminium silicate mineralisation includes primary magnesium aluminosilicates such as feldspars, pyroxenes and chlorite, and hydro thermally-altered silicates such as amphiboles and talc. Sulphide mineralisation is sparse. The feed to Impala's UG-2 plant contains 0.1 to 0.2% sulphides, these are composed mainly of pyrrhotite (roughly 50% of all sulphides), pentlandite (roughly 35%) and chalcocopyrite (roughly 10%).

PGM MINERALOGY

The mix of PGE in UG-2 constitutes roughly 45% platinum, 25% palladium, 10% rhodium and 15% ruthenium. UG-2 also contains minor quantities of copper and nickel sulfides. PGE sulphides

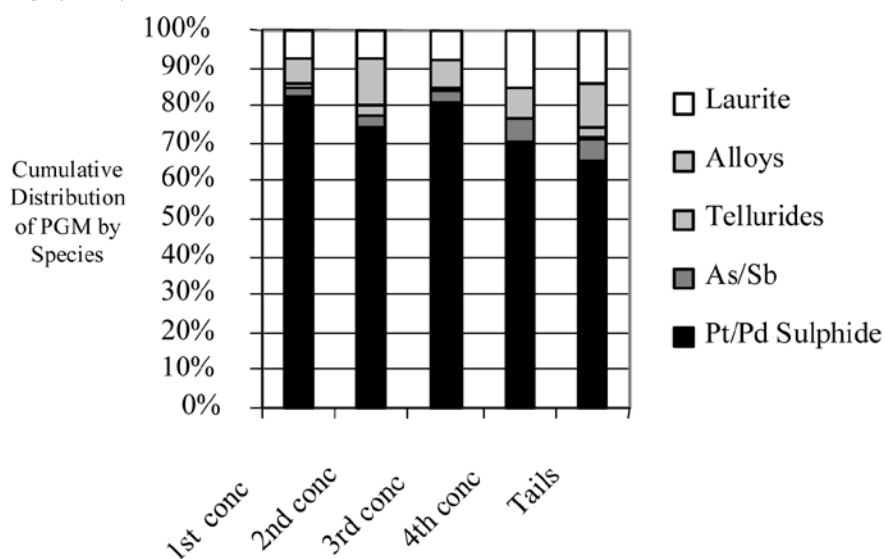

Figure 2: Composition of fast-floating, slow-floating and unfloatable PGM by mineral type

From the metallurgical perspective, however, PGM speciation is a minor issue as it tends not to dictate floatability. For example, QemSCAN studies of the Impala UG-2 plant feed have shown that the mix of fast-floating PGM is similar to that of the slow floating PGM, and the unfloatable PGM (Figure 2), indicating no clear "hierarchy" in mineral floatability. This is consistent with similar studies on the Lac des Iles circuit (1)

PGM, locked in silicates, are difficult to liberate, requiring finer liberation in a secondary milling step, and longer ensuing rougher and cleaner flotation times.

It is, in large part, the nature of the PGM occurrences in the ore that has driven the philosophy of the adopted flowsheet, described later in the paper.

UG-2 ORE PROCESSING PROBLEMS AND SOLUTIONS

Historically UG2 ore could not be processed due to the high chrome content in the feed and subsequently in the final concentrate. Very little of the chrome itself exhibits any degree of positive floatability, but when excessive grinding takes place it reports to the final concentrate in the form of entrainment.

The chrome occurs in the ore as a chrome spinel with iron oxide and only melts at temperatures exceeding 1600deg C. In contrast the furnaces utilized in the platinum industry operate at a much lower temperature of 1400-1500 deg C. Excessive chrome in furnace feeds thus leads to the freezing of the furnaces reducing efficiency and damaging equipment. Thus the maximum allowable chrome in furnace feed was historically limited to about 1 %. Considering that chrome in concentrate for UG2 plants in general were in the region of 3-4% it was extremely difficult to maintain high UG2 processing capacities.

Subsequent developments in furnace technology has allowed concentrates with a chrome content of up to 1.8% being processed and further test work is underway to push this boundary even further. In addition UG2 processing has been refined to the point where concentrates with chrome grades of less than 2.5% are being achieved regularly, as will be seen from this paper. Such chrome levels represent less than 0.3% misplacement of the chrome in the feed, to the final concentrate.

IMPALA UG-2 PLANT HISTORY

UG 2 was first processed by Impala at its Rustenburg operations in 1991 when the first phase of the current UG2 plant was commissioned. The circuit (Figure 3) consisted of two parallel lines, each employing single-stage primary milling followed by rougher and cleaner flotation using Wemco flotation cells, the tails of which were thickened and pumped to a tailings dam. The milling approach, termed run-of-mine ball milling employed mills receiving run-of-mine material, operating at 85% critical speed and using

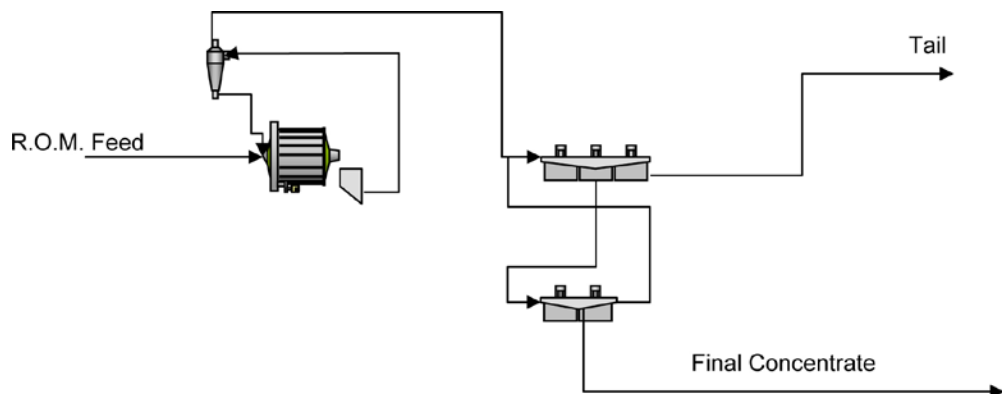

Figure 3: MF1 UG2 plant setup (1991-1994)

high ball loads. The flotation section was a standard rougher/cleaner/re-cleaner cascade configuration with final concentrate being pulled from the re-cleaner cells. This "mill-float" configuration is commonly termed MF1 in South Africa. The primary grind was coarse limiting the risk of chrome entrainment into the final concentrate, but also limiting PGM recovery due to its inherent tendency not to recover more finely disseminated, silicate-association PGM.

Consequently, in 1994 it was decided to improve PGM recoveries by installing regrind milling and "secondary rougher/cleaner flotation, on the existing plant tails (MF2 type circuit - Figure 4). The increased fineness of grind obtained could have led to increased chrome grades and subsequent furnace problems as mentioned earlier but improvements in furnace design allowed for this to be negated. By this time the

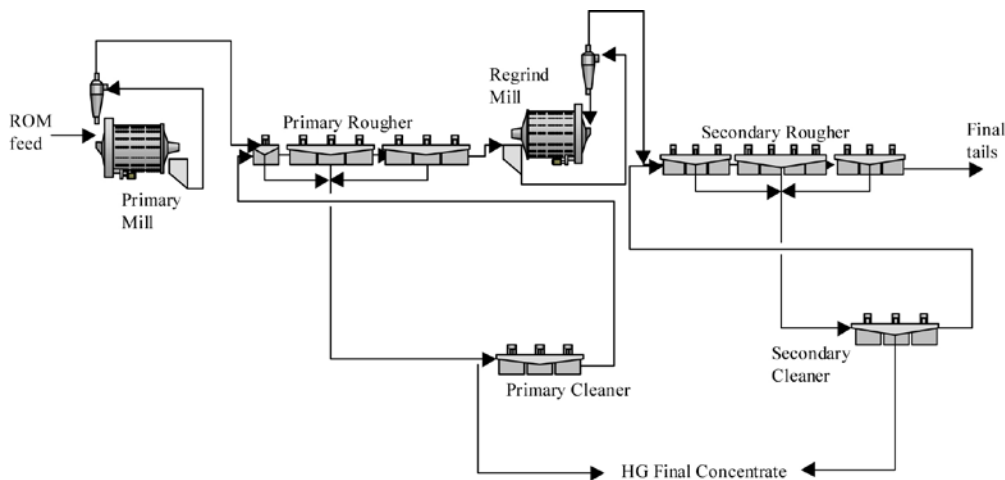

Figure 4 MF2 circuit at Impala's UG2 plant (1994-2001)

processing of UG2 ores had also become common practice and the industry as a whole had developed improved processing practices.

Strategically it became apparent that an increased amount of UG2 ore would have to be processed to maintain overall PGM output, as the existing reserves of Merensky reef low in chromite were slowly being depleted while vast UG2 resources were still available. Subsequently the decision was made to increase the capacity at the UG2 plant and at the same time attempt to improve recovery at acceptable chrome content in final concentrate. This prompted initiation of the UG2 ore separation project.

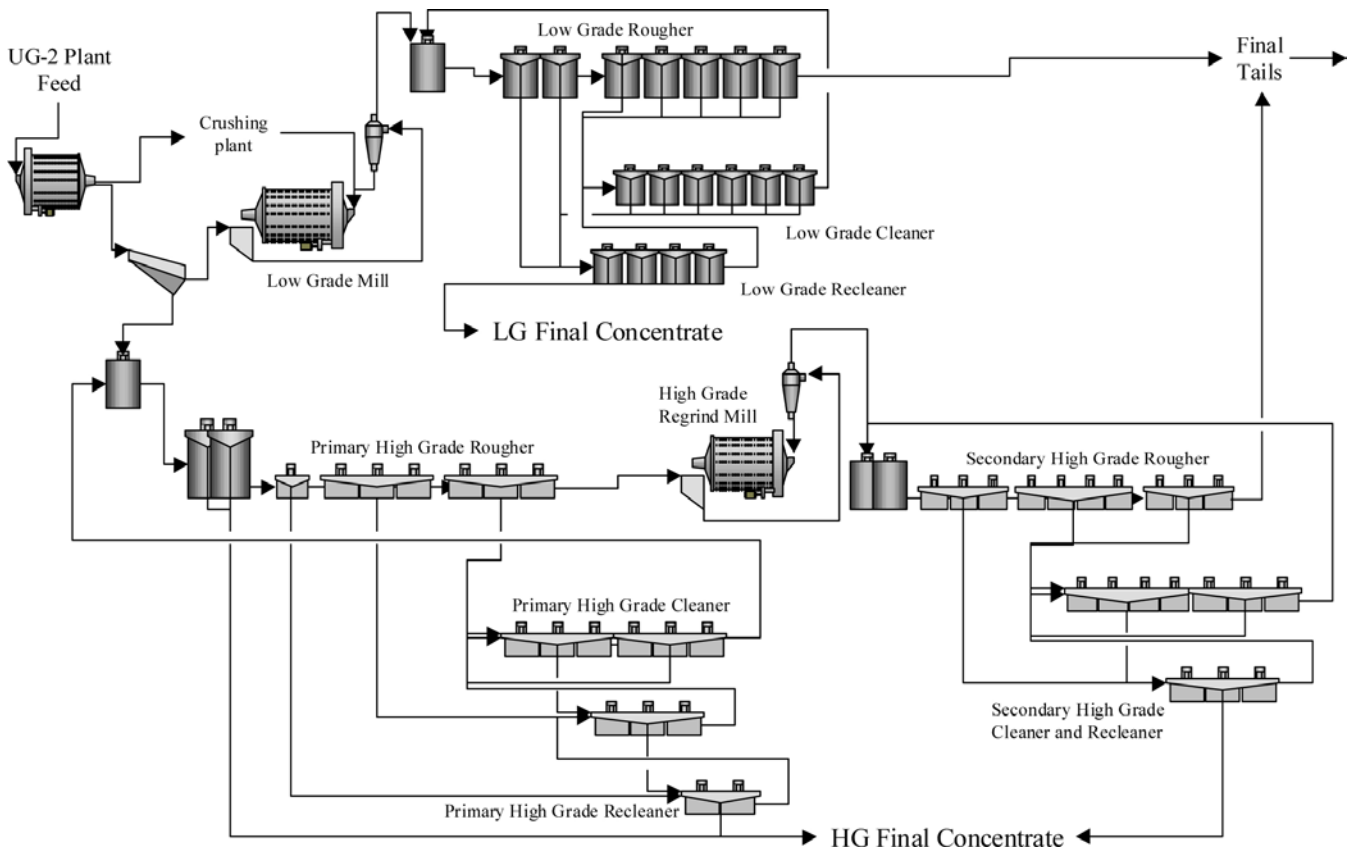

Figure 5 UG2 ore separation basic flow sheet

ORE SEPARATION PROJECT

The concept behind the UG2 ore separation project was derived from the unique nature of UG-2 mineralogy, namely:

- Most PGM rich minerals in the run-of-mine ore are associated with the chrome-rich fraction in the ore (the UG-2 reef itself). The friable nature of the ore and the intergranular location of most of the PGM in this material means that after underground blasting and primary milling, this fraction is relatively fine and the PGM well-liberated.
- The silicate rich fractions in the plant feed (mainly norite, anorthosite etc) contain a much lower PGM content as most of this material originates from the hanging or footwall of the stope face.

The object, therefore, of the primary grinding and classification circuit was to maximise exploitation these mineralogical characteristics. The difference in breakage characteristics of the two ore components is best

exploited by fully autogenous grinding, rather than semi-autogenous grinding. This also allows for crushing of the sizeable stream of silicate pebbles discharging from the autogenous mills, without risk of crusher damage through miss-directed grinding media. This way, it was believed that the primary mill throughput could be increased by about 40%, from 350kt/m to 490kt/m.

This, therefore, represented a rare case when conversion of primary mills from semi-autogenous to fully-autogenous mode had the potential to substantially increase throughput.

The resulting two products from the circuit, namely the finer chrome/PGM-rich material, and the coarser silicate materials could be treated in separate circuits. This allowed for the tailoring of the grinding circuits, flotation circuits and reagent suites to the particular mineralogy of each stream, so ensuring optimal extraction of the contained PGM.

In 1999, Johannesburg-based Mintek launched an extensive pilot plant campaign in order to evaluate the poten-

tial benefits of such a circuit. The results from these studies were sufficiently encouraging to prompt Impala to construct and commission the modified circuit, which started up in 2001.

PROCESS DESCRIPTION

Primary autogenous milling, screening and crushing.

Two 6.4m x 4.9m primary mills (fully autogenous) are operated in parallel at a feed rate of 380 t/hr run of mine ore. A discharge mill trommel on each mill cuts at 12mm with the oversize being crushed through a closed circuit cone crushing plant. The minus 12mm fraction is screened at 600 µm with the oversize recombining with the crushed product to form the low grade circuit feed. The undersize from the classifying screens form the feed to the high grade circuit.

Secondary milling of silicate rich product from primary mills (Low grade mill)

The low grade milling circuit comprises a 9.3m x 6.1m ball mill equipped with a 6.1MW motor, and operating in closed circuit with a cluster of 500mm cyclones.

Typical grinds of 65% passing 75µm are achieved. High chrome grinding media (50mm) are used at a filling degree in the region of 25-28%.

Flotation of silicate rich stream

The feed to this section operates at a grade almost half that of plant feed with a chrome content of 12-14% compared to plant feed chrome content of 20%. The circuit is configured in a conventional rougher/cleaner/re-cleaner configuration, with the cleaner tail in closed circuit with rougher feed and re-cleaner tails forming part of the cleaner feed. The flotation equipment used (Bateman tank cells) range in size from 10 to 50 cubic meters. At the time of start-up, reagents used in this circuit included sodium isobutyl xanthate, sodium dithiophosphate, copper sulphate to activate the iron sulphides, a polyglycol ether frother and a CMC-based polymeric depressant.

Primary flotation of chromite rich (high grade) stream

The basic process flow for the high grade float is similar to the low grade circuit although the existing Wemco cells are still being used in conjunction with two newly installed Bateman tank cells. Oversized mechanisms (Wemco 190's) are used in the Wemco 164 rougher cells to ensure they can be started under load. Float feed to this section is quite coarse at 30% -75µm, rich in high SG chrome and has a pulp density of 1.65 g/cm³. The cleaner tails are directed to the head of the primary rougher banks with rougher tails forming the feed to the secondary/regrind mill. Although the suite of reagents used in this circuit was, at start-up similar to the low grade circuit, considerably more reagent is used in this circuit.

Regrind of chromite rich (high grade) stream

Regrinding of both primary float rougher tail streams is achieved through a single ball mill identical in size to the low grade mill, and also equipped with a 6.1MW motor. Grinding media consists of 35mm high chrome steel balls with a filling degree of 25-28%. Initially this circuit was run in closed circuit with a cluster

of cyclones, but was recently modified to an open circuit with two stage classification, as described in more detail later in the paper. Product from this circuit is roughly 65% passing 75 microns and controlled at a density of 1.45 g/cm³.

Secondary flotation of chromite rich (high grade) stream

The secondary high grade flotation section follows an almost identical configuration to the primary float although smaller 144 (8.5 m³) Wemco cells are used. The PGM targeted in this float are somewhat finer and/or more locked than those in the primary rougher flotation circuit, so the kinetics tend to be somewhat slower. Consequently, the residence time in this circuit is somewhat longer.

COMMISSIONING ISSUES

A number of mechanical as well as metallurgical problems were experienced during the changeover from conventional MF2 milling to the High grade/ Low grade split operation. Most of these were centered on the milling circuits, the most prominent ones being the following:

Primary autogenous mill control

A number of problems were experienced with the mill pebble ports failing resulting in oversized material reporting to the crushers. It was also important to get the right size pebble ports in order to maintain throughput through the mill and at the same time maintain mill load.

For the operations personnel there was a steep learning curve operating an autogenous mill compared to the previous run-of-mine ball mills. It was found that mill power draw fluctuated due to large fluctuations in mill feed size distribution. Various methods were attempted to negate this but eventually the most effective was for the mill operators to visually select different mill feeders in order to obtain coarser feed sizes to the mills. Ultimately, operation proved too complex for manual control, and an expert system was successfully developed by Impala staff to control mill operation.

Flotation circuit sanding, chokes and abrasion issues.

The main mechanical and operational issues encountered were as a result of the coarse primary grinds as well as the abrasive nature of the chromite ore. This led to a number of line chokes as well as sanding up of float banks. As a result float densities of 1.65 are maintained in the primary section with densities of 1.45 on the secondary float in order to keep the particles in suspension. Final tailings are also kept at a slurry density of 1.6 to ensure the correct pumping efficiencies are maintained. However due to the abrasiveness of the chromite particles regular maintenance and changeovers is still required. This was also very evident in the mill liner lives of the regrind mills.

METALLURGICAL PERFORMANCE

The changeover to the new ore separation circuit was motivated based mainly on increased throughput, but, secondarily, on increased recoveries believed to be obtainable from this type of ore split. Once steady mechanical operations were established, the design throughput of 380t/hr per mill was consistently achieved. Even though the required tonnage increase was realized, the increase in recovery could never be obtained. Plant tails grades remained close to 1g/t (combined Pt, Pd, Au and Rh), well above the 0.75 g/t target. Consequently, Impala decided to embark on a structured process optimization project in conjunction with numerous technology partners including SGS Lakefield, Hatch Africa and Mintek.

THE STRUCTURED OPTIMISATION PROGRAMME

All too often, optimisation efforts conducted after the start-up of complex mineral processing circuits range from disorganised to chaotic, particularly when plant management are under pressure to rapidly achieve results. Considerable effort, and often extensive resources are devoted to solving seemingly intangible

problems, a plethora of metallurgists and consultants all eagerly, and randomly, searching for the holy grail of the metallurgical fix – that which will solve the problems overnight. This is not only inefficient, but also leads to considerable confusion, stemming from the wide variety of “solutions” proposed, often based on independently collected datasets and observations.

Structured optimisation programmes were developed by two of the authors to diffuse such situations, during the post-commissioning optimisation of several South African PGM circuits in the early 1990’s. The object of the structured optimisation programme is to maximise the efficiency of the technical resources directed to optimise the plant, by focusing the effort, adhering to simple mineral processing “basics”, but also being comprehensive in the approach.

Broadly, the programmes consist of three different phases:

PHASE 1:

- Data gathering,
- Identification and implementation of low-cost, rapidly engineered opportunities for process improvements, and,
- Identification of opportunities for low-risk, high-return capital projects to achieve further improvements in plant performance.

PHASE 2:

- Evaluation of candidate capital projects.
- Risk management of the capital projects.

PHASE 3:

- Implementation of capital projects.
- Follow-up data gathering.

Prior to the presently described optimisation programme, such projects have successfully optimised mineral processing circuits in the platinum industry in South Africa, in the silver industry in the United States and most recently at the Lac des Iles operation in Ontario (1). In each case the programme smoothed and, most likely, greatly accelerated the optimisation of the respective operations – substantial increases in plant concentrate grades and/or recoveries achieved in each case.

PHASE 1

ACTIVITIES DURING PHASE 1

24 hour composite data gathering.

A suite of 24 hour composites were collected daily by shift personnel, the objective being to be able to create a daily mass balance of each stage of flotation in the entire circuit. This served several purposes:

- It provided a historically robust data population on the broad mass balance of the circuit, enabling the metallurgists to identify the best- and worst-performing parts of the circuit, so helping to focus the more detailed data-gathering efforts.
- It provided a “mother data population” against which individual survey data could be evaluated for long-term representativity.
- It created samples for size-by-size diagnostic metallurgy.

Detailed Surveys

Surveys were conducted on selected parts of the plant, where the greatest potential for benefit was perceived to exist. Initially, the plan was to conduct detailed surveys on all sections in the plant. However, evidence arising from the other work, and the sheer complexity associated with surveying such a large circuit made this both unnecessary and impossible. Where

conducted, the surveys:

- Created kinetics data, including size-by-size kinetics data on banks of flotation cells in the circuit.
- Created complete water and solids mass balances, using Bilmat software.
- Established typical operating practices throughout this part of the circuit, including cell operation, reagent dosage, motor power draws etc.

Examples of the data generated from studies of the high grade primary rougher circuit, are shown in Table 1.

Flotation diagnostic studies

Campaigns of flotation tests were implemented on selected streams. Such tests were conducted numerous times for each stream. This not only built up a robust, historically-based data population, but it also served as an excellent training tool for the on-site technicians, who became highly adept at floating key streams in the plant (a skill not usually present in a newly commissioned plant). This in turn improved the quality of reagent and grinding optimisation testwork, implemented on an ongoing basis as data were gathered from the surveys and 24-hour sampling campaigns.

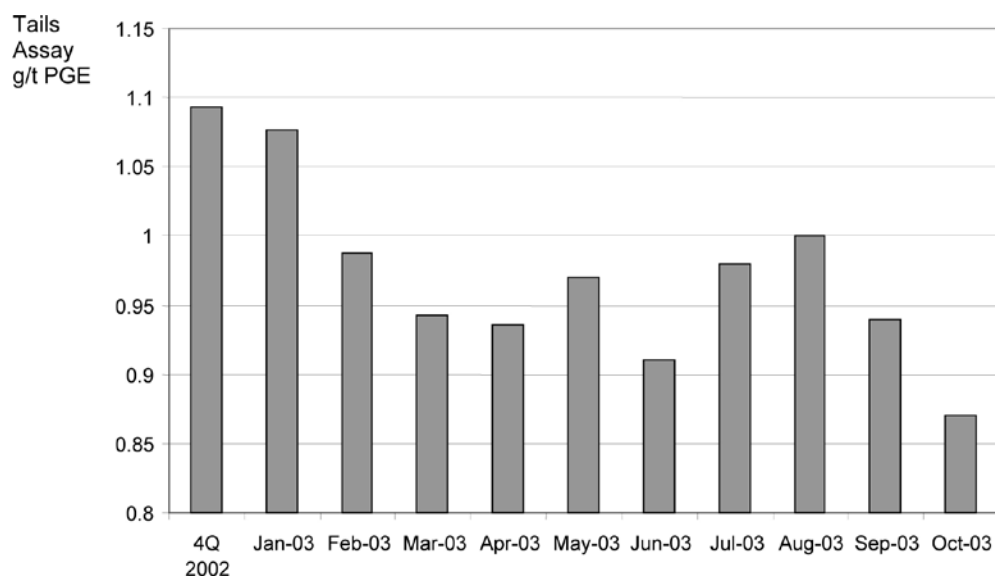

Figure 6: Change in UG-2 Plant Tails Assays, January – June 2003

- **Rougher Feed:** These studies were initiated to create an understanding of the mass pull/recovery relationships of the rougher flotation circuits (past experience had shown that material transfer problems associated with talcous PGM concentrates often lead to less than optimal flotation mass pull rates). The laboratory data could then be compared with the data from the 24-hour composite programme and the detailed surveys to identify the potential for improved recoveries associated with eliminating pumping restrictions and so pulling more concentrate.
- **Rougher Tails:** Flotation tests on the tails were as powerful as those on the feed streams, as they provided a direct indication of the “floatable” values being lost to tails. These tests were conducted on all tails streams, particularly those that are delivered out of the plant (although the high grade primary rougher tails stream, feeding the regrind milling circuit was also studied).
- **Cleaner Tails:** Completeness of flotation tests were also conducted on cleaner tails streams.

RESULTS

Several quick-fixes were identified during this phase, perhaps the most significant being optimisation of the high grade regrind cyclones in January, and establishing a different reagent suite in May, to better balance mass pull rates. The results are shown in terms of changes in plant tailings assays, in Figure 6.

During the year, recoveries improved from 71% in the fourth quarter of 2002 to an average of over 75% for the period from June to September 2003.

Phase 1 also identified three significant candidate long-term fixes, all pertaining to the high grade circuit, losses from which contribute more than 79% of the PGE sent to the tailings impoundment:

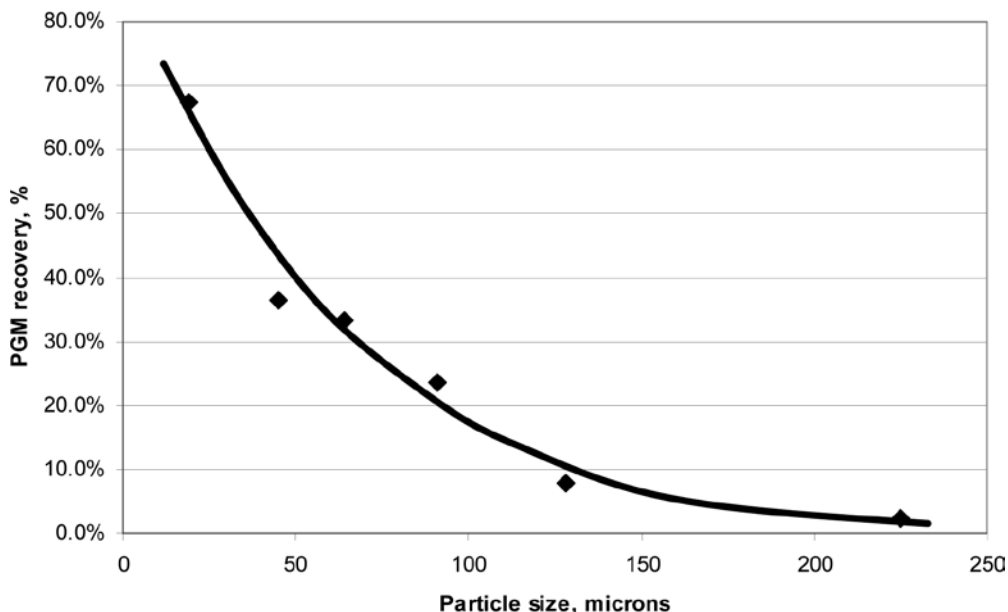

Figure 7: Size-by-Size PGM Recovery, High-grade Secondary Rougher Flotation

HIGH GRADE REGRIND CIRCUIT OPTIMISATION: SEMI-OPEN CIRCUIT REGRINDING

The two predominant phases in UG-2 ores are high SG chromitite and lower SG silicate minerals. PGM associated with chromitite are almost universally found along grain boundaries, and the friable nature of the chromitite grain structure means that these PGM are readily liberated with relatively little grinding. Conversely, the PGM associated with the silicate phases are more commonly intergrown into the host silicate grains, often being completely locked in the silicate phase. As described earlier in this paper, it is these PGM that need to be liberated using the high-grade regrind milling circuit, as reflected by the secondary rougher size-by-size recovery relationship shown in Figure 7. Clearly, the objective of the regrind circuit would be to maximise the production of floatable, minus-38 micron PGE.

However, closed circuit regrinding merely led to accumulation of the dense, PGM-barren chromite in the circulating load, leading to wasted energy and an increased tendency for the PGM-rich silicate minerals to by-pass the grinding circuit completely. The effect of this was clearly demonstrated through the size distribution of the chrome and PGM in the high-grade regrind circuit feed and product, shown below (Figures 8 and 9). Note how the abundance of chrome in the -38 micron fraction has risen by 24%. Conversely, note how the abundance of PGM in the -38 micron fraction rose only marginally, by 3.5%. The circuit did little to liberate PGM, and created significant ultra-fine chrome increasing the entrainment of chrome to the final concentrate.

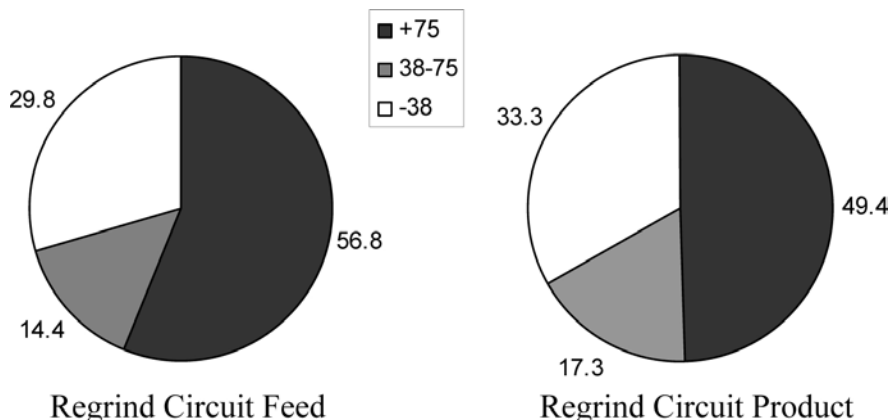

Figure 8: Distribution of PGM to the +75, 38-75 and -75 micron Size Fractions

Clearly this is one of those rare cases where closed circuit regrind milling does not improve grinding circuit efficiency, at least as measured by the degree of increased liberation of the values.

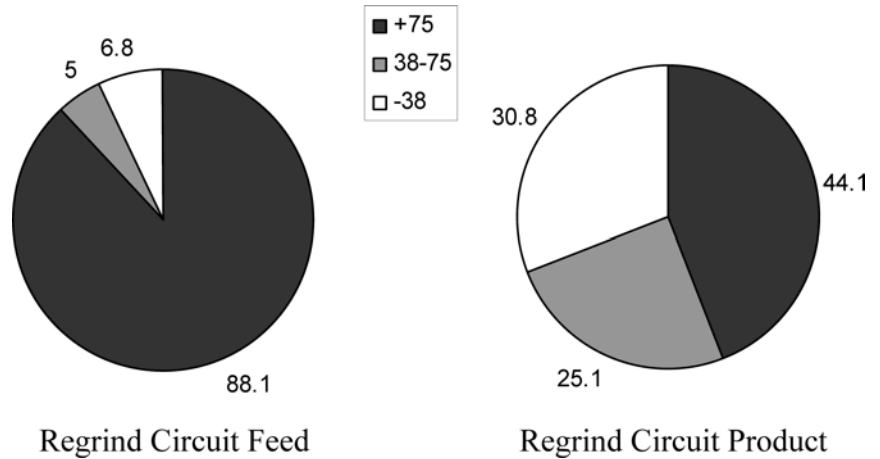

Figure 9: Distribution of Chrome to the +75, 38-75 and -75 micron Size Fractions

Table 1: Mass and Metallurgical Balance from Surveying the Impala UG-2 High Grade Rougher Circuit, show original and Bilmatabalanced data.

SURVEY #2 - PRIMARY HG CIRCUIT, JULY 8, 03									
SECTION 1									
SAMPLES		DATA INPUT				BILMAT			
		ASSAY				CALCULATED RESULTS			
		ACTUAL		INPUT TO BILMAT		WEIGHT			REC
		PGM	Cr ₂ O ₃	PGM	Cr ₂ O ₃		PGM	Cr ₂ O ₃	PGM
No.	Description	g/t	%	g/t	%	%	g/t	%	%
1	Prim HG Feed - Section 1	4.86	23.2	4.86	23.2	100.0%	4.84	21.9	100.0%
2	Prim HG Tank Cell Fd - Section 1	5.09	20.8	5.09	20.8	101.5%	4.95	21.7	103.9%
3	Prim HG Tank Cell Conc - Section 1	230.0	2.93	230	2.93	0.58%	237	2.89	28.3%
34	Prim HG Tank Cell-2 Tail - Section 1	3.63	20.0	3.63	20.0	100.9%	3.62	21.8	75.6%
35	Prim HG Rghr Cell 1 Conc - Section 1	76.8	4.86	76.8	4.86	0.53%	77	5.08	8.4%
36	Prim HG Rghr Cell 1 Tail - Section 1	8.9	11.3	3.20	22.0	100.4%	3.24	21.9	67.2%
40	Prim HG Rghr Comb Conc - Section 1	58.8	4.77	58.8	4.77	1.49%	58.5	6.03	18.1%
4	Prim HG Rougher Tail - Section 1	2.39	24.8	2.39	24.8	98.9%	2.4	22.1	49.2%
41	Prim HG ReCl Feed - Section 1	79.9	4.57	79.9	4.57	2.2%	78.8	5.59	35.2%
6	Prim HG Reclnr Conc - Section 1	209	3.66	209	3.66	0.51%	215	3.34	22.5%
42	Prim HG ReCl Tail - Section 1	37.1	6.49	37.1	6.49	1.7%	37	6.28	12.7%
43	Prim HG Comb Clnr #1 Feed - Section 1	29.9	7.57	40.0	7.57	3.1%	47.2	6.16	30.7%
44	Prim HG Clnr #1 Cell 1/3 Conc - Section 1	139.0	4.34	139.0	4.34	0.45%	139.2	4.24	13.1%
45	Prim HG Clnr #1 Cell 3 Tail - Section 1	31.7	7.3	31.7	7.3	2.7%	31.7	6.49	17.6%
46	Prim HG Clnr #1 Cell 4/6 Conc - Section 1	100.0	3.89	100.0	3.89	0.49%	100.2	3.85	10.1%
47	Prim HG Clnr #1 Cell 6 Tail - Section 1	16.80	7.7	16.80	7.7	2.2%	16.6	7.06	7.6%
48	Prim HG Clnr #1 Cell 7/9 Conc - Section 1	25.4	8.12	25.4	8.12	0.69%	25.6	8.08	3.7%
5	Prim HG Cleaner Tails - Section 1	12.4	8.71	12.40	8.71	1.5%	12.49	6.60	3.9%
12	Second HG Conc. - Section 1	123	3.70	73.0	4.86	1.73%	70.0	4.55	25.1%
7	HG Concentrate - Section 1	73	4.86	123	3.70	2.81%	130	3.99	75.9%
Calc	Overall Tails			1.20	22.0	97.2%	1.20	22.4	24.1%

EXTENDED RESIDENCE TIME IN THE HIGH GRADE SECONDARY ROUGHER CIRCUIT

Incomplete flotation was demonstrated repeatedly through tailings re-flotation tests (Figure 10). Although this could partly be ascribed to low mass pulls in the existing rougher circuit, it was concluded that increasing the mass pull alone would not necessarily recover all the lost PGM from the high grade secondary rougher tails. Up to 30% of the PGM in the secondary high grade rougher tails could be re-floated. This represented 7% of the PGM in the total plant feed. Such recoveries were achieved at relatively low mass pull rates, indicating, quite good selectivity but slow flotation kinetics.

CLEANER CIRCUIT RATIONALISATION

As all cleaner tails streams circulate to the head of rougher banks, the effect of inefficient cleaner performance is somewhat masked. However, the accumulation of large quantities of

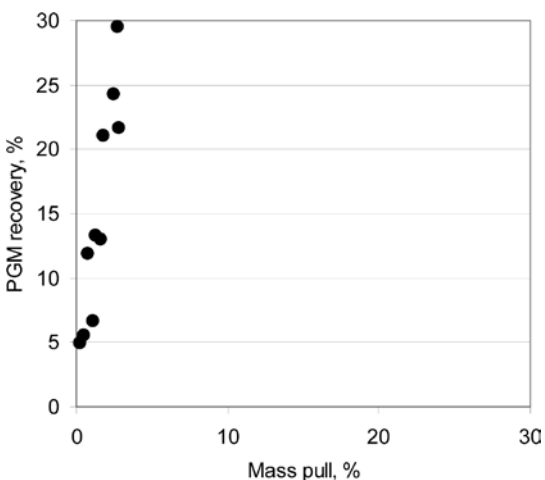

Figure 10: Re-flotation of the High Grade Secondary Rougher Tailings

circulating PGM in cleaner tails streams is symptomatic of an inappropriate cleaner circuit configuration, indicating that slow-floating PGM are finding it hard to report to final concentrate. In PGM circuits, this problem can be exacerbated by the competitive flotation of talc and other hydrophobic silicate minerals.

Such circulating loads were evident from the Phase 1 studies, prompting more in-depth analysis of this problem in Phase 2.

Primary HG rougher tails

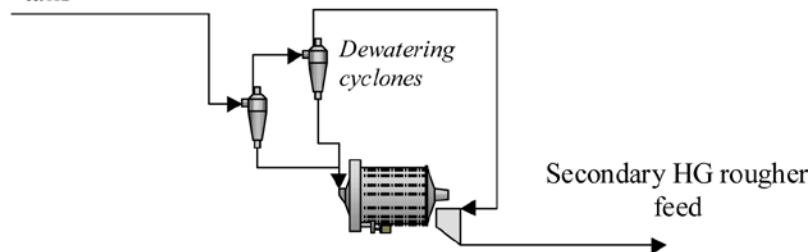

Figure 11: Modified High Grade Secondary Regrind Circuit

PHASE 2

SEMI-OPEN CIRCUIT REGRINDING

Modification of the existing circuit was relatively straightforward, cheap and offered relatively little technical or economic risk. The circuit, as shown in Figure 11, involved simply the installation of cyclones essentially designed as dewatering or deslime cyclones, configured to achieve a nominal cut-size of 15 microns. This circuit was installed with no loss in plant availability and was commissioned without hitch in late September 2003.

The circuit had an immediate impact on high-grade circuit recoveries, and indeed on overall plant performance, increasing plant PGM recoveries, at the time of writing, by between 1.5 and 2%.

CLEANER CIRCUIT RATIONALISATION

The cleaner circuit design did not recognise the varying floatabilities of different rougher concentrate streams. Flotation tests on successive UG-2 plant rougher concentrate streams sampled down the banks, showed that while PGM flotation kinetics decline, the flotation kinetics of the floatable silicate gangue species actually rise, presumably as on-going conditioning of these silicates in the rougher banks enhances their floatability. This is sometimes seen in PGM circuits, where the most stable, silicate-rich froths are often seen at the tail end of the circuits. In fact, laboratory flotation tests of the final stage rougher concentrates showed that the silicates had become faster-floating than the PGM themselves, leading to a certain degree of reverse flotation in cleaning. Figure 12 illustrates that the material floated in the first few minutes of cleaning is actually lower grade than the material floated later. This problem can be solved, in part, with extra dosages of depressant to control the silicate floatability, however a more effective, and increasing common solution in UG-2 circuits, lies in providing a separate outlet for the production of a slow-floating, lower grade secondary final concentrate. This solution appears to apply to the Impala UG-2 plant.

Further, excellent correlations were obtained between the proportion of PGM rejected from rougher concentrate cleaner tests, and the abundance of fully-locked PGM in the rougher concentrate streams, as established by QemSCAN analysis. This indicates an important role for cleaner tails regrinding, the subject of pilot plant testwork progressing on-site at the time of writing.

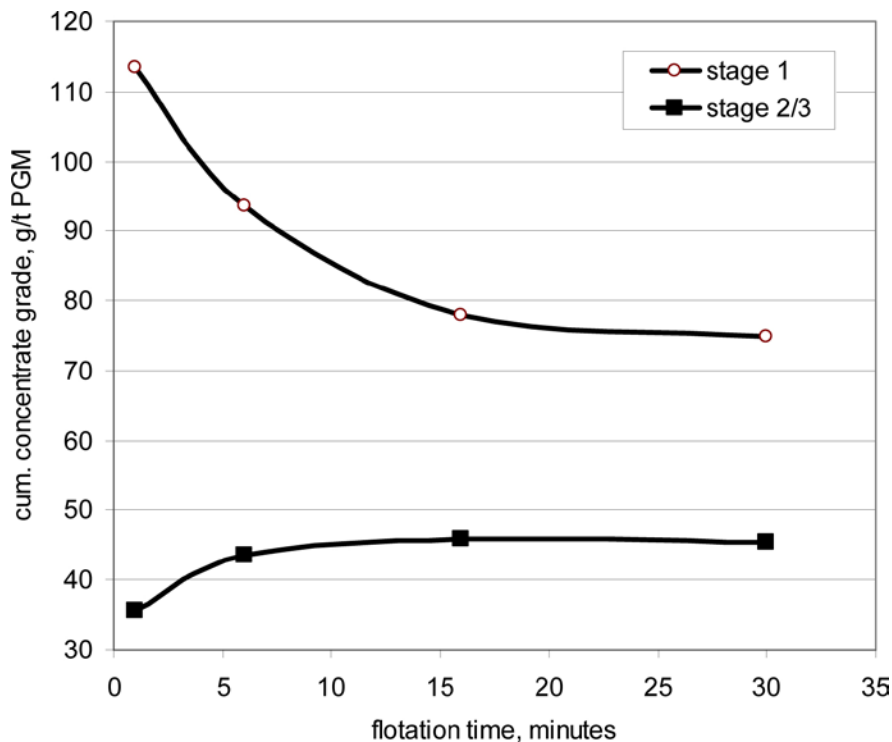

Figure 12: Change in Concentrate Grade with Time during Cleaning of Secondary Rougher Concentrates.

Further, excellent correlations were obtained between the proportion of PGM rejected from rougher concentrate cleaner tests, and the abundance of fully-locked PGM in the rougher concentrate streams, as established by QemSCAN analysis. This indicates an important role for cleaner tails regrinding, the subject of pilot plant testwork progressing on-site at the time of writing.

PHASE 3

Phase 3 involves the implementation of capital projects and at the time of writing this is under evaluation. It also involves a new data gathering programme, where the progress in plant optimisation is evaluated and new opportunities identified. Essentially, therefore, the programme cycles through phases 1 to 3 until the data gathering exercises indicate that all economically viable opportunities for process improvement have been exhausted.

CONCLUSIONS

Impala’s ore separation project, and the attendant commissioning of one of the industry’s most interesting PGM circuits, has proven to be a great success in achieving the target expanded throughput rates.

In so doing, Impala have defied conventional wisdom by substantially increasing throughput by converting mills from semi-autogenous to fully-autogenous mode.

In so doing, Impala have defied conventional wisdom by substantially increasing throughput by converting mills from semi-autogenous to fully-autogenous mode. The achievement of target recoveries is proving more of a challenge, but these targets may now be in sight.

However, by focusing resources and providing a comprehensive overview of plant performance, the structured implementation of straightforward, conventional process optimisation techniques has proven to be a valuable way of rapidly arriving at the broad optimisation of the circuit.

ACKNOWLEDGEMENTS

The authors wish to acknowledge the hard work of the metallurgists and technicians on Impala's UG-2 Plant, and the valuable input by consultants from Hatch Africa, Mintek and Eurus Mineral Services. Our thanks also to the management of Impala Platinum Limited for authorising the presentation of this paper.

REFERENCES

Martin, C.J. Ohrling, T, Olsen, T and Taggart, P: Addressing Palladium Flotation Start-up Problems at the New Lac Des Iles Concentrator, Thunder Bay, Ontario, presented to the 35th Annual CMP meeting, Ottawa, January 2003.

CONTACT INFORMATION

Email us at minerals@sgs.com

WWW.SGS.COM/MINERALS

© 2011 SGS. All rights reserved. The information contained herein is provided "as is" and SGS does not warrant that it will be error-free or will meet any particular criteria of performance or quality. Do not quote or refer any information herein without SGS' prior written consent. Any unauthorized alteration, forgery or falsification of the content or appearance of this document is unlawful and offenders may be prosecuted to the fullest extent of the law.

NEED TO BE SURE

SGS